

Data Sheet

WÖHR MULTIPARKER 710/720/730



Please observe the separate Technical Notes!



The Multiparker utilizes clever and smart the available surface and provides parking space with different variants.

- As tower and/or pit version
- Automatically operated parking systems for 10 to more than 100 cars
- Variable system length available
- Multiple row arrangement with up to 2 parking rows behind each other
- Well adaptable to individual project requirements
- Safe for user and cars (no narrow ramps, dark stairs, no damage caused by theft or vandalism)
- Customizable arrangement of transfer area
- Very fast access time by use of a quick-change pallet system
- No ramps and driving lanes
- No costly illumination and ventilation necessary
- Different car heights possible, e.g. Vans, SUVs
- For car weight up to 2.5 t, higher loads are possible after consultation with WÖHR
- Easy operation with several control options, e.g. transponder chip or remote control
- Suitable for apartment- and office buildings and for public parking
- Following the idea of "Green Parking"

Multiparker 710 | Tower system for 2-8 parking levels

- Parking system for 2-8 parking levels as tower variant
- Linear expansion variable (see dimension D on table below)
- Variable arrangement of transfer area (see page 8)

- Vehicles of various height can be parked thanks to parking levels of various height
- Multi-row arrangement (see page 8)
- Quick-change pallet system = short access times
- Integrated turning device possible (option)

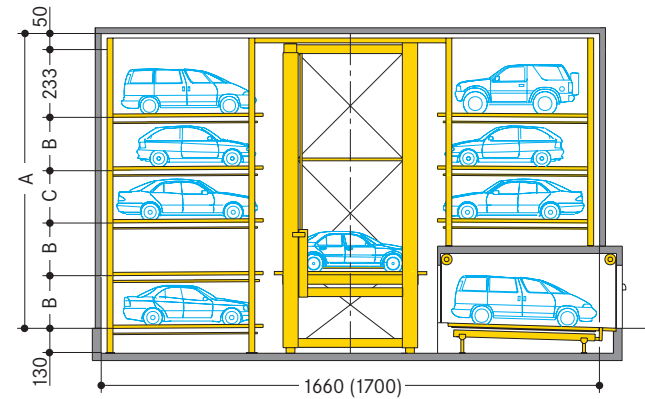

Transfer area (dimensions without turning device)

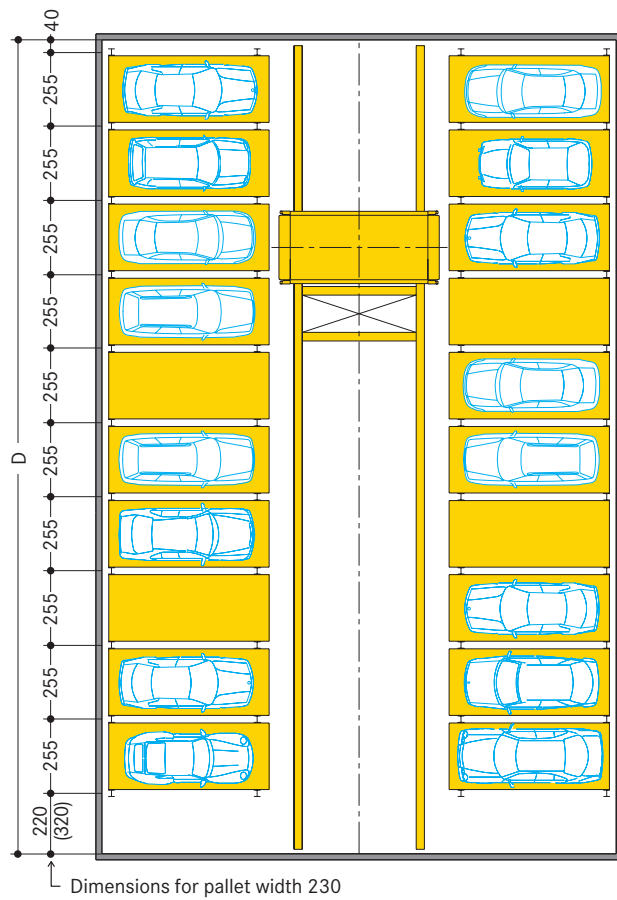
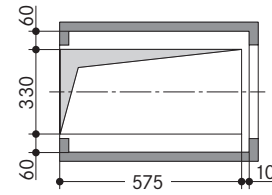

() Dimensions in brackets for storage and retrieval unit with turning device

For the control unit, space (at least length 500 cm x width 200 cm x height 240 cm) must be available near the transfer area.

Parking levels	Dimension A for 160 cm high cars	Dimension A for 200 cm high cars
2	476	516
3	689	769
4	882	1002
5	1075	1235
6	1288	1488
7	1481	1721
8	1674	1954

Car height	Dimension B	Dimension C
160	193	213
185	218	238
200	233	253

Parking places per level*	Pallet width 230 Grid width 255 cm Length D
12	1790
14	2045
16	2300
18	2555
20	2810
22	3065
24	3320
26	3555
28	3830
30	4085
32	4340
34	4595
36	4850
38	5105
40	5360

* The number of parking places depends on number and arrangement of transfer areas

Dimensions in cm

Multiparker 710 | Shaft system for 2-8 parking levels

- Parking system for 2-8 parking levels as shaft variant
- Linear expansion variable (see dimension D on table below)
- Variable arrangement of transfer area (see page 8)
- Vehicles of various height can be parked thanks to parking levels of various height
- Multi-row arrangement (see page 8)
- Quick-change pallet system = short access times
- Integrated turning device possible (option)

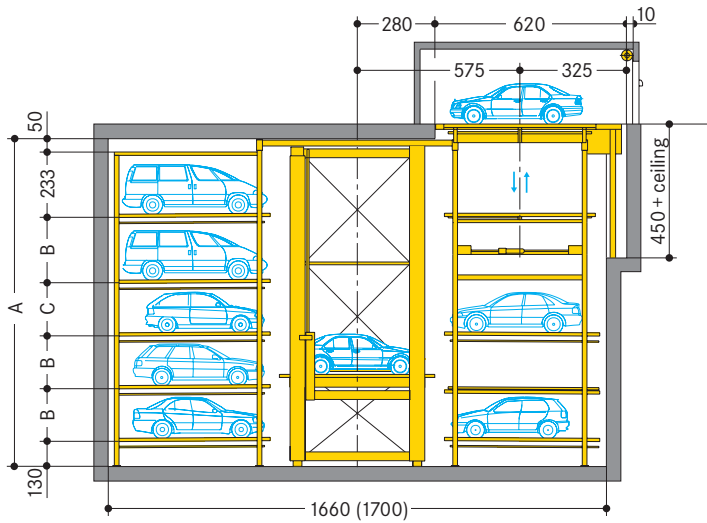

Transfer area (dimensions without turning device)

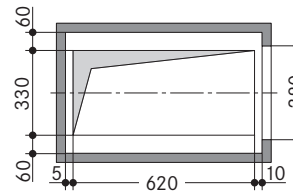

Parking levels	Dimension A for 160 cm high cars	Dimension A for 200 cm high cars
2	606	646
3	819	899
4	1012	1132
5	1205	1365
6	1418	1618
7	1611	1851
8	1804	2084

Car height	Dimension B	Dimension C
160	193	213
185	218	238
200	233	253

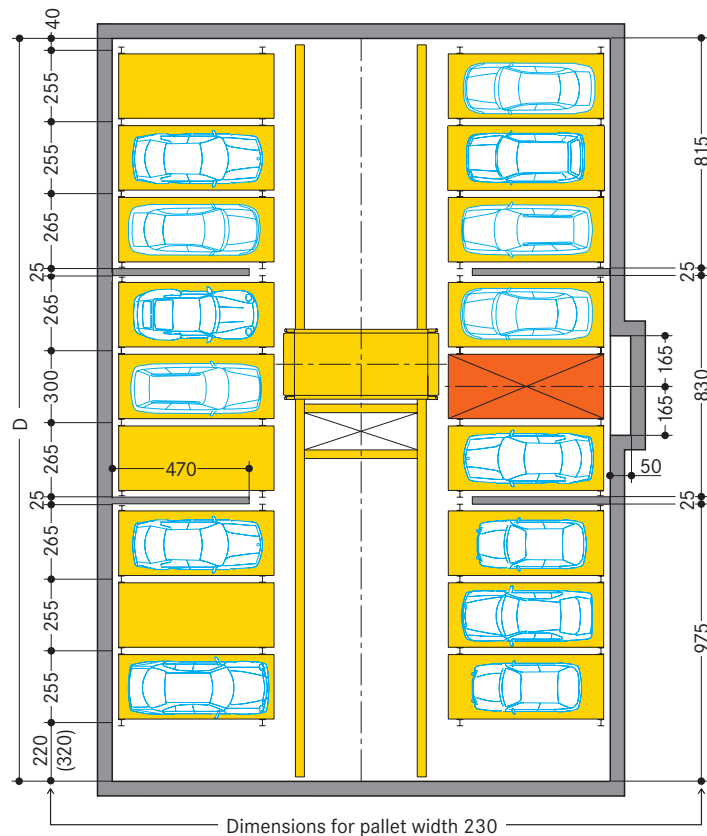

Parking places per level*	Pallet width 230 Grid width 255 cm Length D**
12	1880
14	2180
16	2435
18	2690
20	2990
22	3245
24	3500
26	3800
28	4055
30	4310
32	4610
34	4865
36	5120
38	5420
40	5675
42	5930

* The number of parking places depends on number and arrangement of lifts
 ** All specified dimensions of length D are examples only and depend on width and number of partitions walls

Dimensions in cm

() Dimensions in brackets for storage and retrieval unit with turning device

For the control unit, space (at least length 500 cm x width 200 cm x height 240 cm) must be available near the transfer area.

Multiparker 720 | Tower system for 4–20 parking levels

- Parking system for 4-20 parking levels as tower variant
- Linear expansion limited to max. 6 parking bays per row
- Variable arrangement of transfer area (see page 8)

- Vehicles of various height can be parked thanks to parking levels of various height
- Multi-row arrangement (see page 8)
- Quick-change pallet system = short access times
- Integrated turning device possible (option)

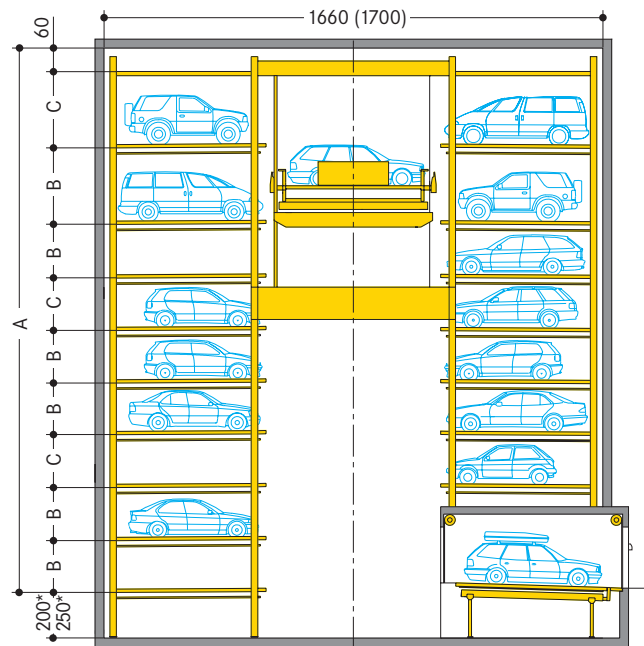

Transfer area (dimensions without turning device)

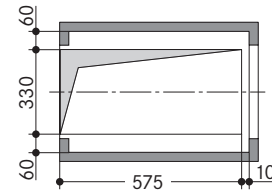

* Dimension 200 cm apply to 4 or 8 parking places per level
Dimension 250 cm apply to 10 or 12 parking places per level

() Dimensions in brackets for storage and retrieval unit with turning device

Parking levels	Dimension A for 160 cm high cars	Dimension A for 200 cm high cars
4	852	1012
5	1045	1245
6	1258	1498
7	1451	1731
8	1644	1964
9	1857	2217
10	2050	2450
11	2243	2683
12	2456	2936
13	2649	3169
14	2842	3402
15	3055	3655
16	3248	3888
17	3441	4121
18	3654	4374
19	3847	4607
20	4040	4840

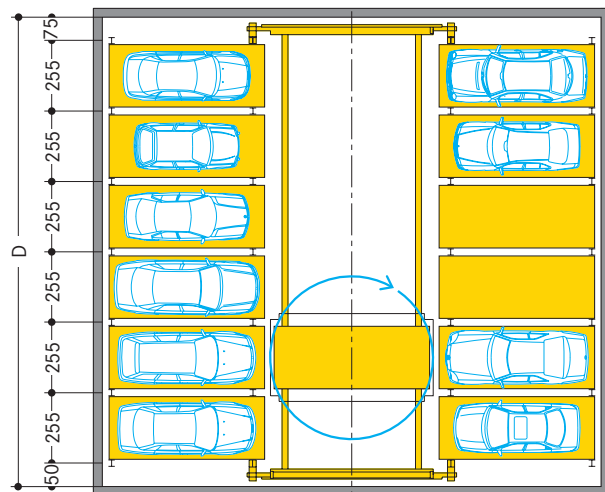

Dimensions for pallet width 230

Car height	Dimension B	Dimension C
160	193	213
185	218	238
200	233	253

Parking places per level**	Pallet width 230 Grid width 255 cm Length D
6	890
8	1145
10	1400
max. 12	1655

** The number of parking places depends on number and arrangement of transfer areas

Dimensions in cm

For the control unit, space (at least length 500 cm x width 200 cm x height 240 cm) must be available near the transfer area.

Multiparker 720 | Shaft system

- Linear expansion limited to max. 6 parking bays per row
- Variable arrangement of transfer area (see page 8)
- Vehicles of various height can be parked thanks to parking levels of various height

- Multi-row arrangement (see page 8)
- Quick-change pallet system = short access times
- Integrated turning device possible (option)

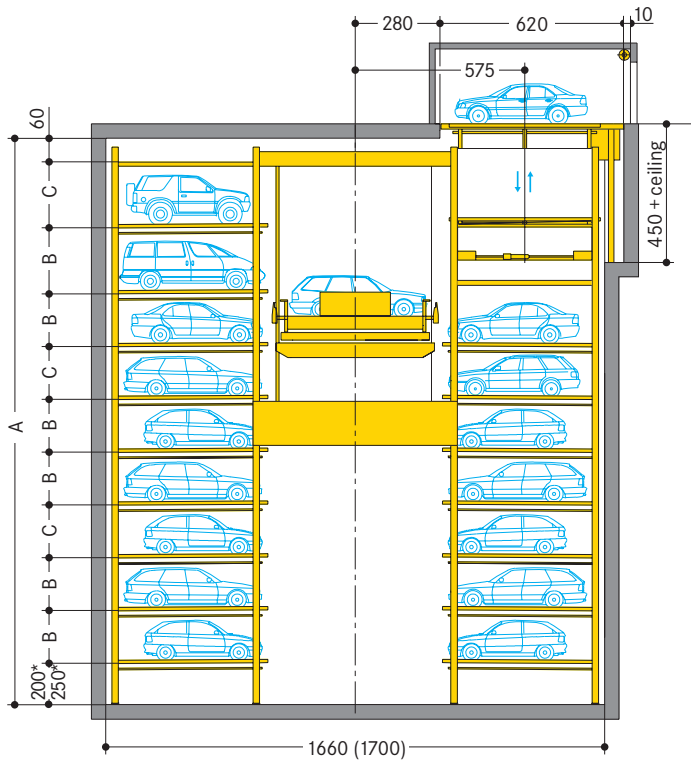

Transfer area (dimensions without turning device)

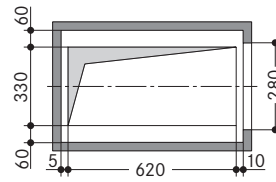

Parking levels	Dimension A** for 160 cm high cars	Dimension A** for 200 cm high cars
1	453	493
2	646	726
3	859	979
4	1052	1212
5	1245	1445
6	1458	1698
7	1651	1931
8	1844	2164
9	2057	2417
10	2250	2650
11	2443	2883
12	2656	3136

** All mentioned dimensions apply to 6 or 8 parking places per level. If 10 or 12 parking places per level are planned, these dimensions are to be increased by 50 cm.

* Dimension 200 cm apply to 6 or 8 parking places per level
Dimension 250 cm apply to 10 or 12 parking places per level

() Dimensions in brackets for storage and retrieval unit with turning device

Car height	Dimension B	Dimension C
160	193	213
185	218	238
200	233	253

Parking places per level***	Pallet width 230 Length D****
6	935
8	1235
10	1490
max. 12	1745

*** The number of parking places depends on number and arrangement of transfer areas

**** All specified dimensions of length D are examples only and depend on width and number of partitions walls

Dimensions in cm

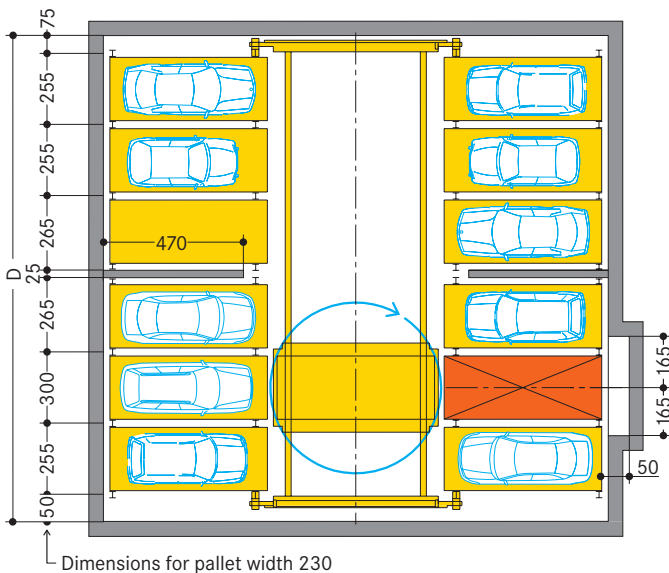

For the control unit, space (at least length 500 cm x width 200 cm x height 240 cm) must be available near the transfer area.

Multiparker 730 | Shuttle/Lift system with steel structure

- Parking system for a high number of parking spaces and a high throughput
- Separate shuttle in each parking level
- Each parking level connected with entrance/exit level by lifting unit
- Linear expansion variable (see dimension D on table below)
- Vehicles of various height can be parked thanks to parking levels of various height
- Multi-row arrangement (see page 8)
- Quick-change pallet system = short access times
- Integrated turning device in the transfer area possible (option)

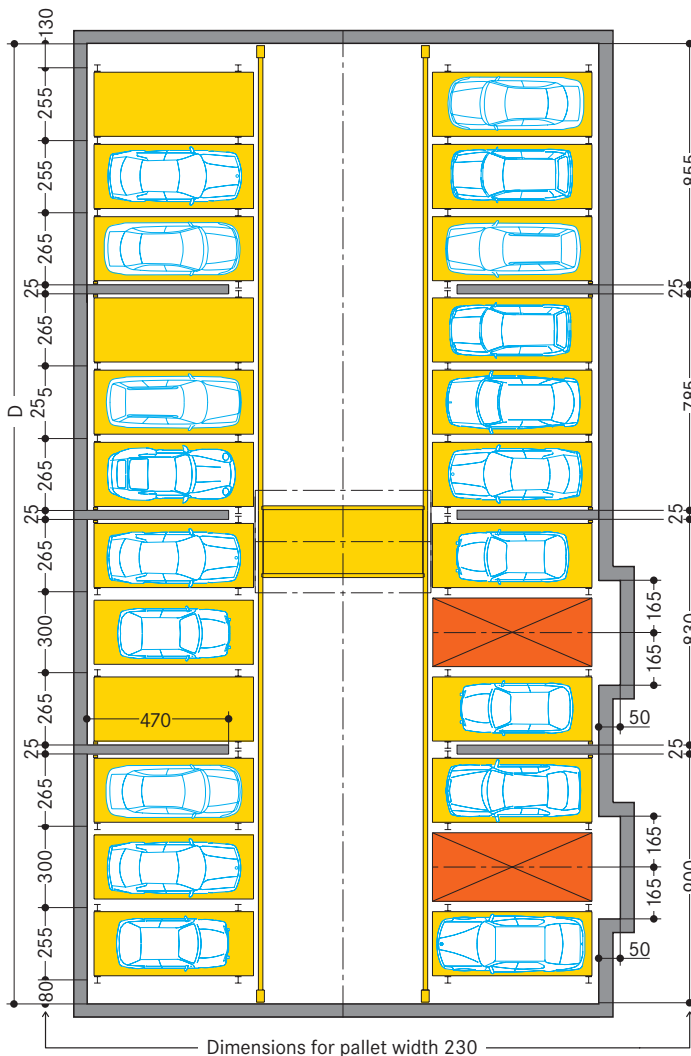
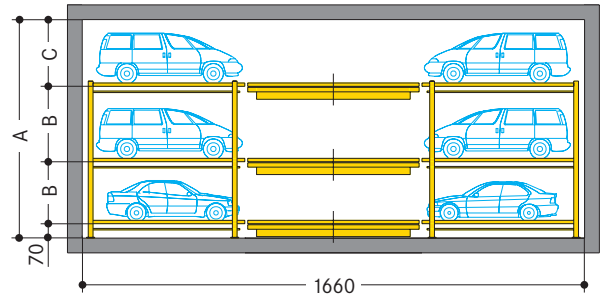
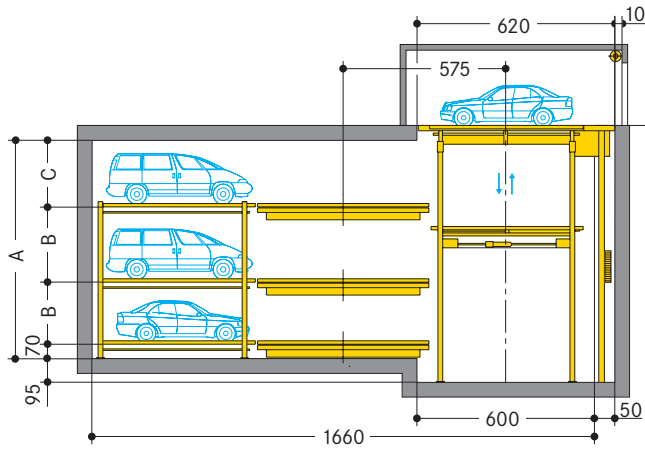

Transfer area (dimensions without turning device)

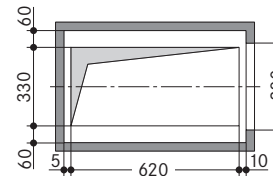

Parking levels	Dimension A for 160 cm high cars	Dimension A for 200 cm high cars
2	465	545
3	690	810
4	915	1075
5	1140	1340

Car height	Dimension B	Dimension C
160	225	170
185	250	195
200	265	210

Parking places per level*	Pallet width 230 Length D**
22	3495
24	3795
26	4050
28	4305
30	4605
32	4860
34	5115
36	5415
38	5670
40	5925
42	6225
44	6480
46	6735
48	7035
50	7290

For the control unit, space (at least length 500 cm x width 200 cm x height 240 cm) must be available near the transfer area.

* The number of parking places depends on number and arrangement of the lift

** All specified dimensions of length D are examples only and depend on width, number of partitions walls and number of lifts

Dimensions in cm

Multiparker 730 | Shuttle/Lift system with intermediate ceiling

- Parking system for a high number of parking spaces and a high throughput
- Separate shuttle in each parking level
- Each parking level connected with entrance/exit level by lifting unit
- Linear expansion variable (see dimension D on table below)
- Vehicles of various height can be parked thanks to parking levels of various height
- Multi-row arrangement (see page 8)
- Quick-change pallet system = short access times
- Integrated turning device in the transfer area possible (option)

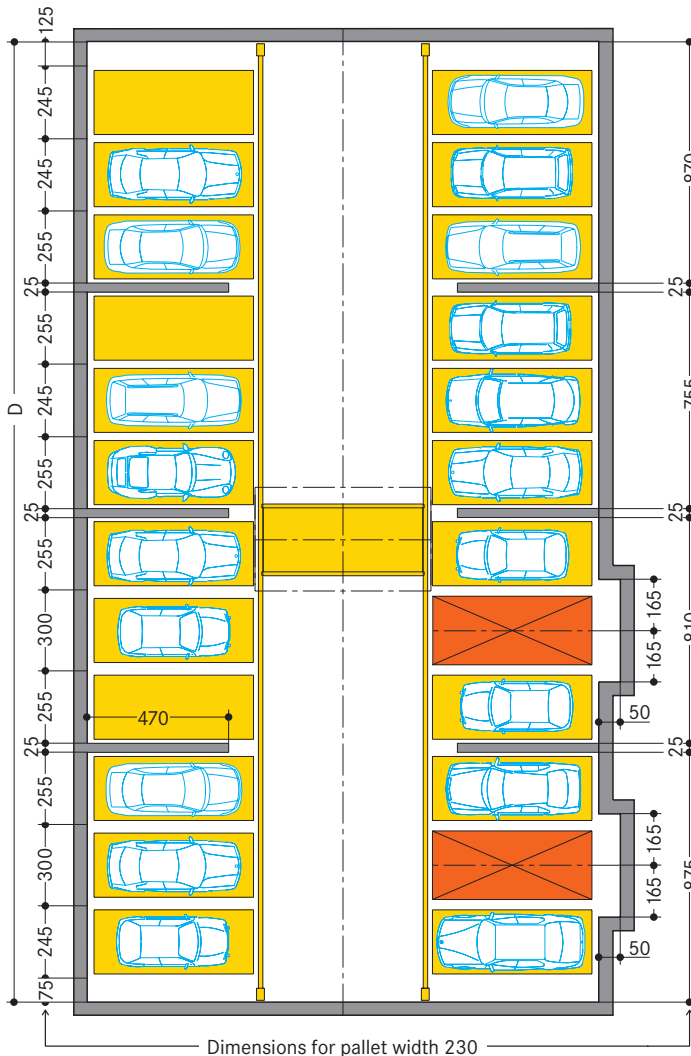
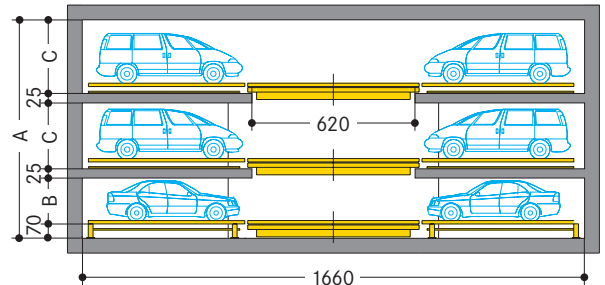
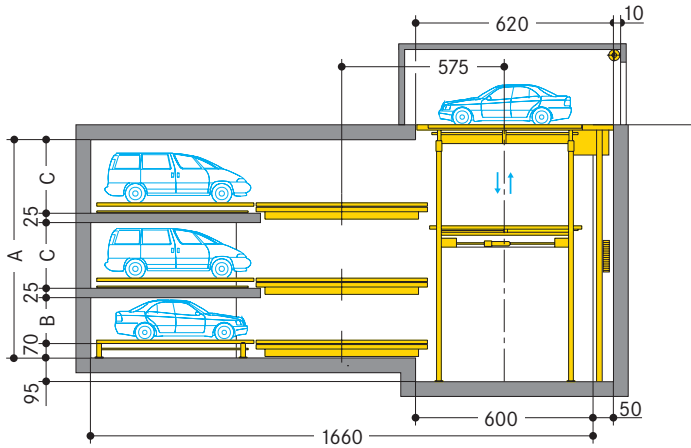

Transfer area (dimensions without turning device)

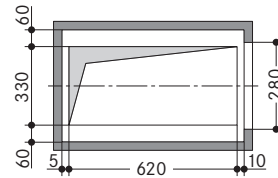

Parking levels	Dimension A for 160 cm high cars	Dimension A for 200 cm high cars
2	471	551
3	704	824
4	937	1097
5	1170	1370

Car height	Dimension B	Dimension C
160	168	208
185	193	233
200	208	248

Parking places per level*	Pallet width 230 Length D**
22	3385
24	3675
26	3920
28	4165
30	4455
32	4700
34	4945
36	5235
38	5480
40	5725
42	6015
44	6260
46	6505
48	6795
50	7040

For the control unit, space (at least length 500 cm x width 200 cm x height 240 cm) must be available near the transfer area.

* The number of parking places depends on number and arrangement of the lift

** All specified dimensions of length D are examples only and depend on width, number of partitions walls and number of lifts

Dimensions in cm

Multi-row arrangement

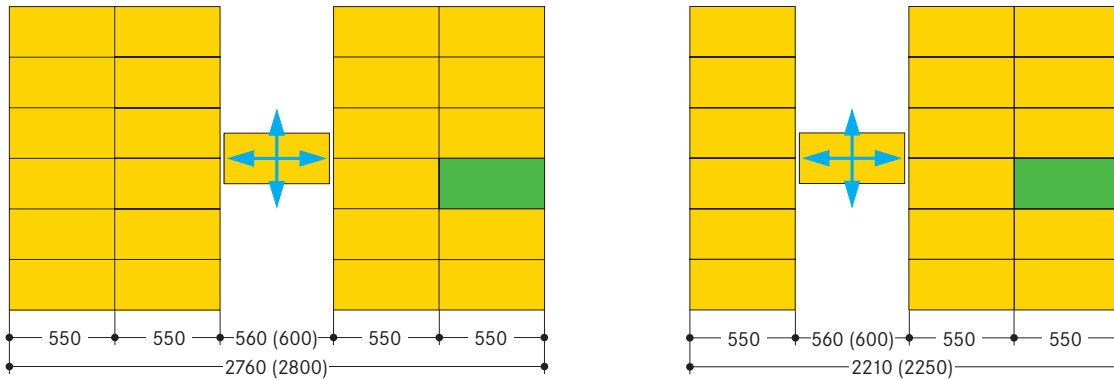

The multi-row arrangement allows an optimum utilisation of the available space and/or land area and saves civil engineering costs, particularly with the shaft variant.

() Dimensions in brackets for storage and retrieval unit with turning device

Possible arrangements of transfer area

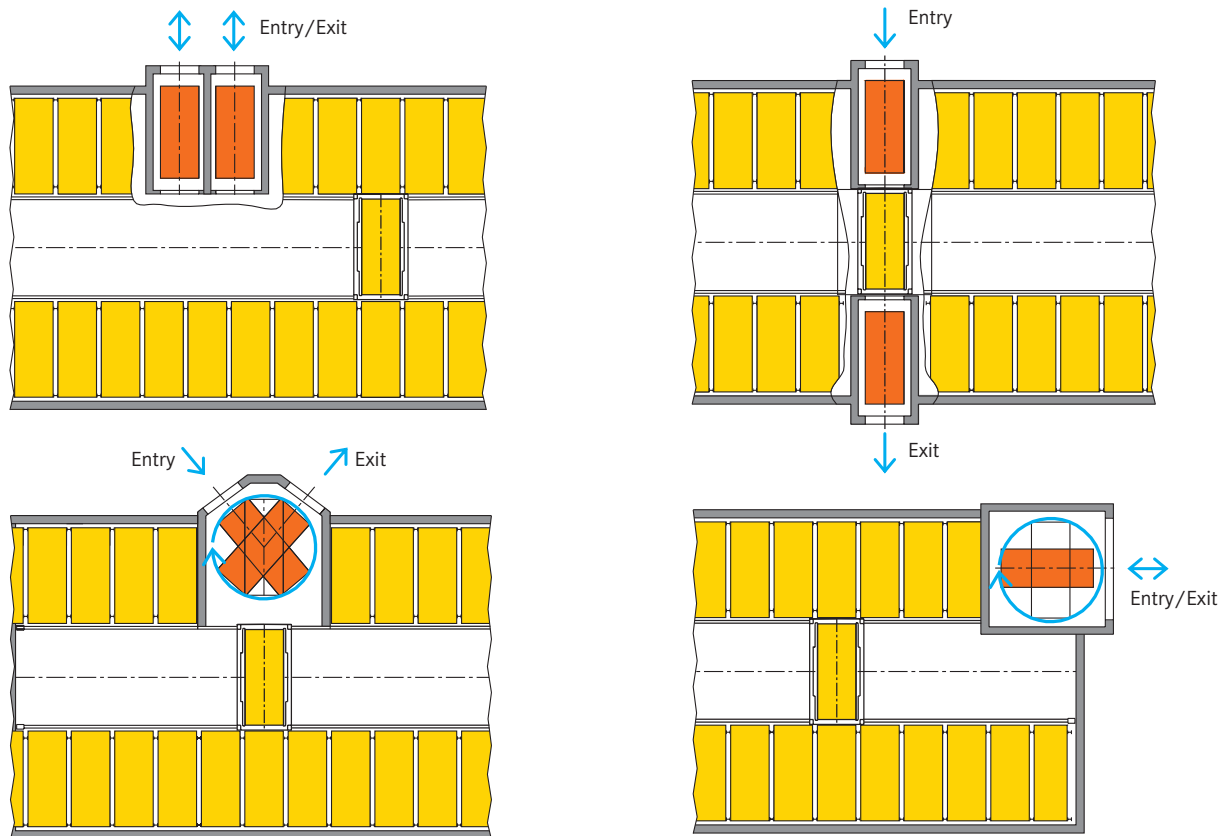

The arrangement of the transfer area is flexible. The optimum arrangement is always in the system center which has the shortest access times. Depending on the need and kind of utilisation, the number of the transfer areas can be adapted.

Maintenance access and switch cabinet

Maintenance access as well a room for the switch cabinet (min. 2 x 5 m) is required (please check with WÖHR).

Max. car dimensions

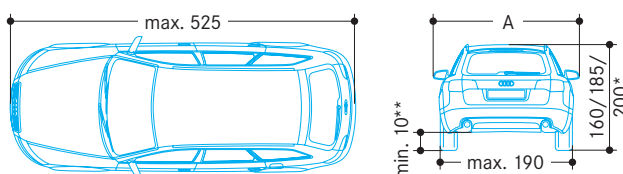

* Overall height (cars with roof racks, roof rails, antennas etc. should not exceed the mentioned overall height).
 ** Clearance underneath the gear case

Pallet width	Dimension A
230	220

Car weight max. 2500 kg, wheel load max. 625 kg.
 These car dimensions are valid for the building dimensions as mentioned. If building dimensions are adjusted, other car dimensions are possible.

For parking systems with EV charging options, WÖHR recommends the use of wider pallets.

Attention: Clear installation dimensions change accordingly.