

■ WÖHR Bikesafe 885/16 (74 parking places), handlebar width 76 cm

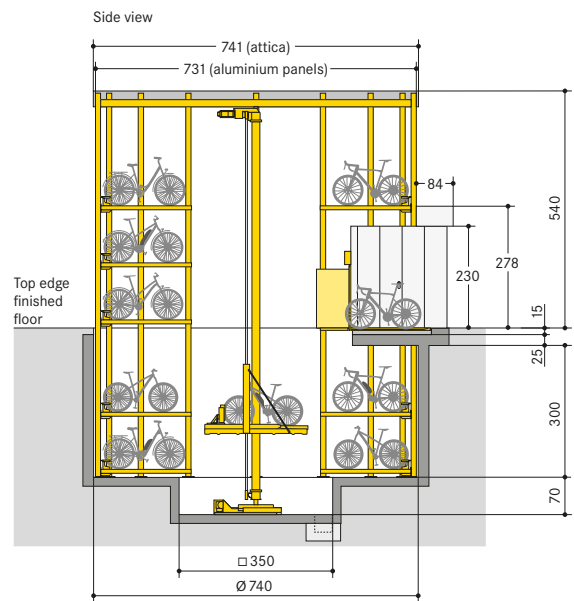

Note: if possible, provide an access door in the shaft area.

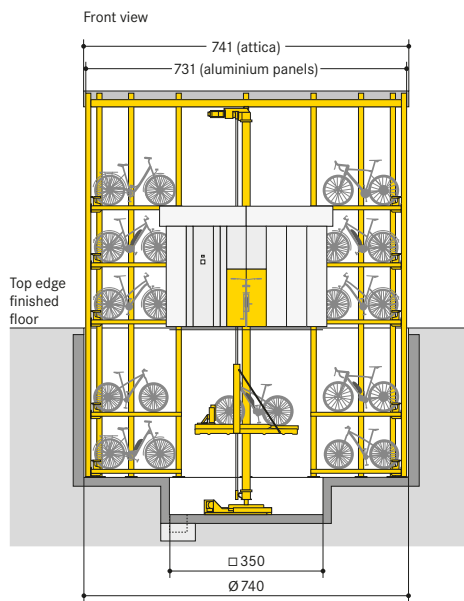
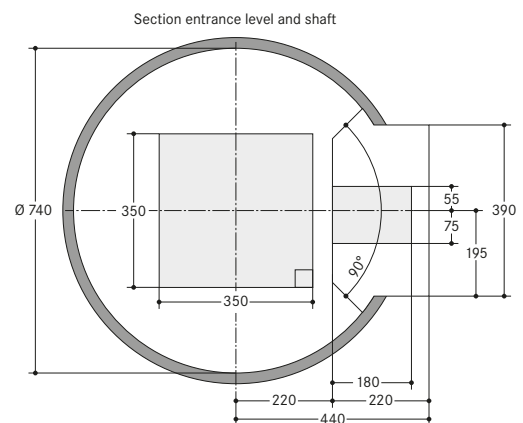
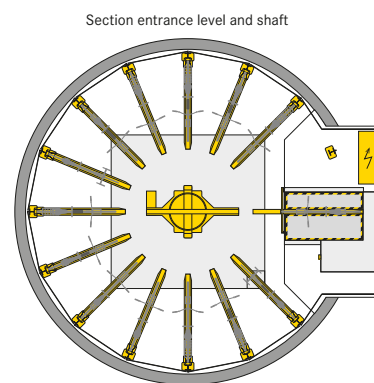
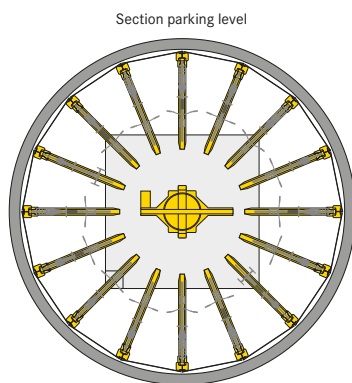

■ WÖHR Bikesafe 885/16 (74 parking places), handlebar width 83 cm

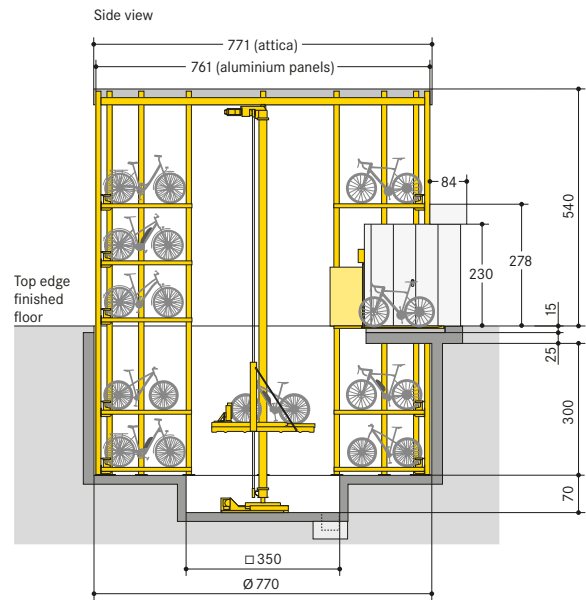
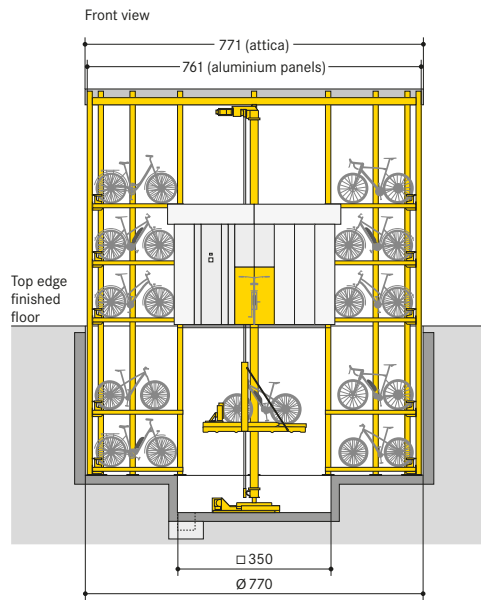

Note: if possible, provide an access door in the shaft area.

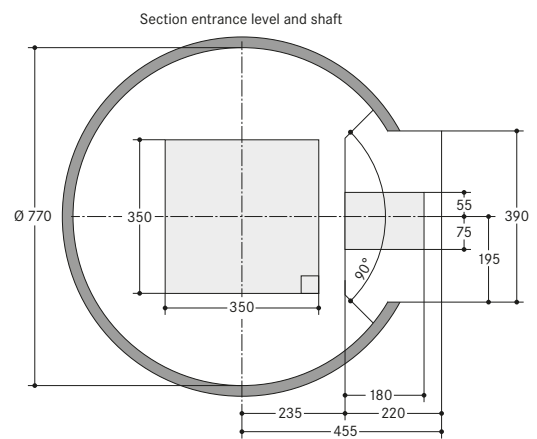
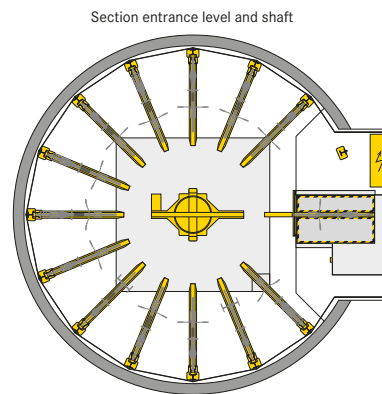
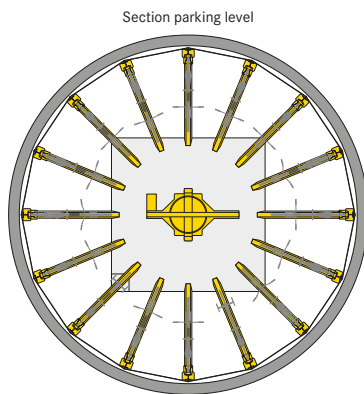

■ WÖHR Bikesafe 885/20 (94 parking places), handlebar width 76 cm

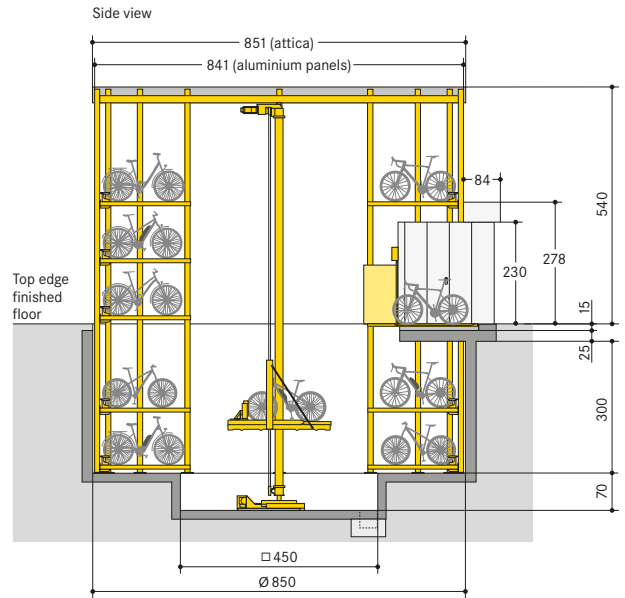
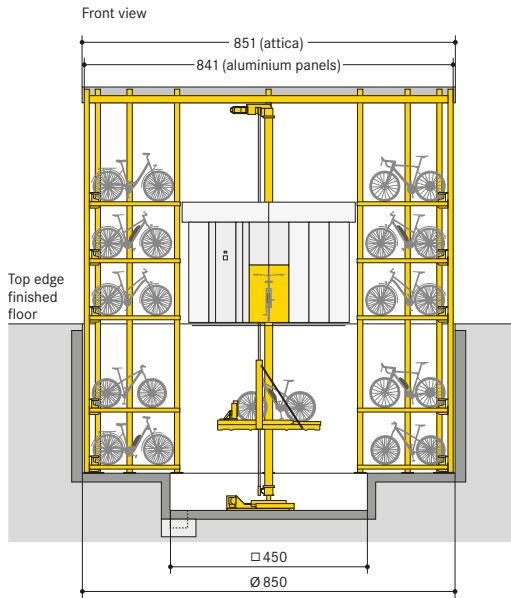

Note: if possible, provide an access door in the shaft area.

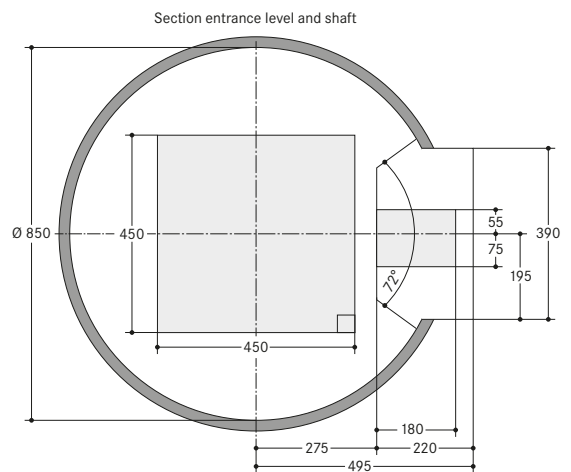
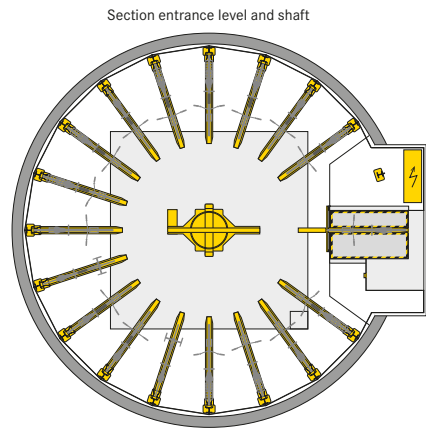
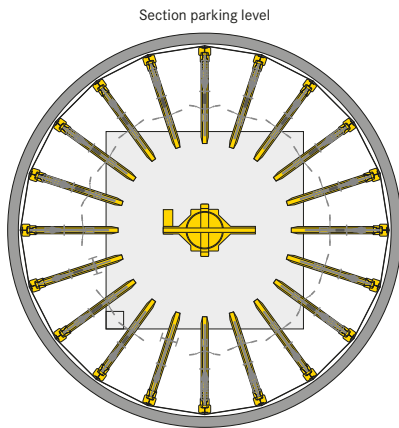

■ WÖHR Bikesafe 885/20 (94 parking places), handlebar width 83 cm

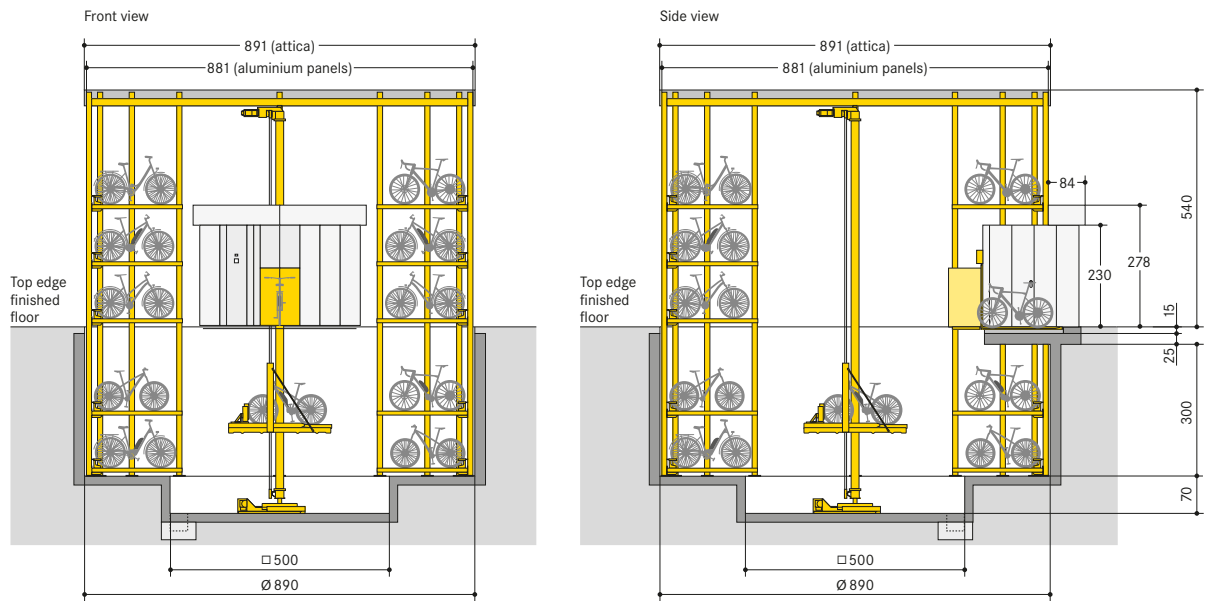

Note: if possible, provide an access door in the shaft area.

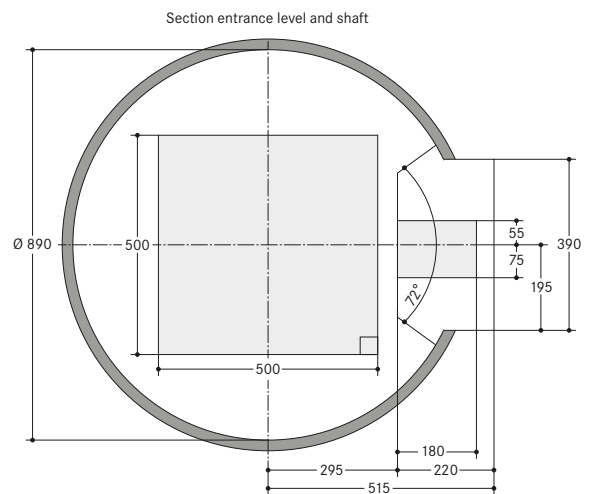
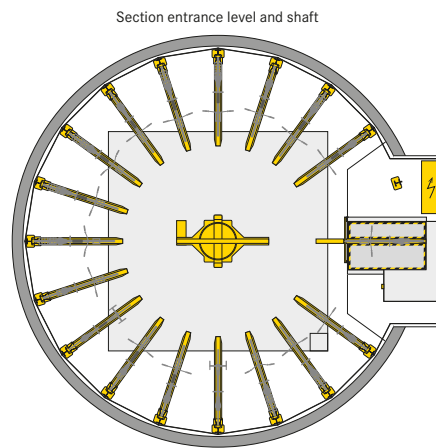
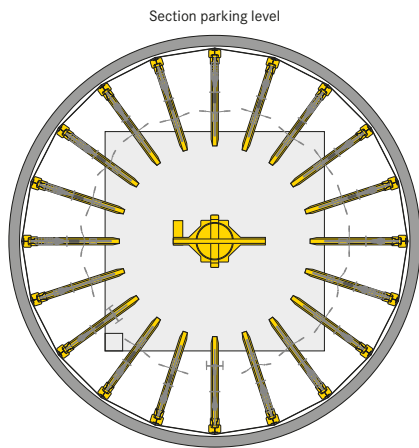

■ WÖHR Bikesafe 885/24 (114 parking places), handlebar width 76 cm

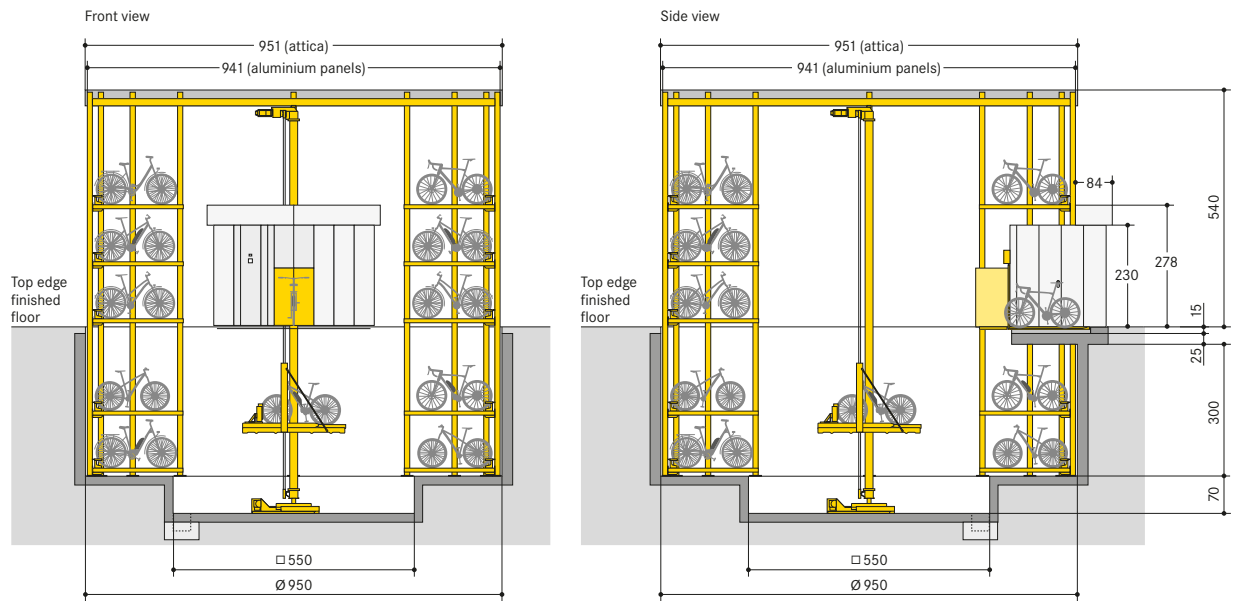

Note: if possible, provide an access door in the shaft area.

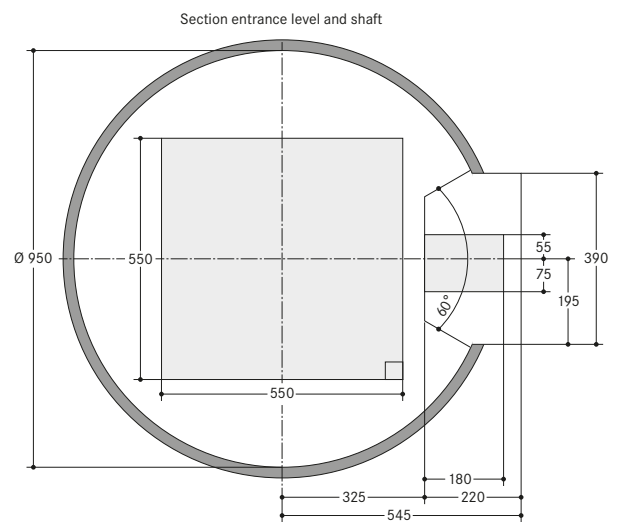
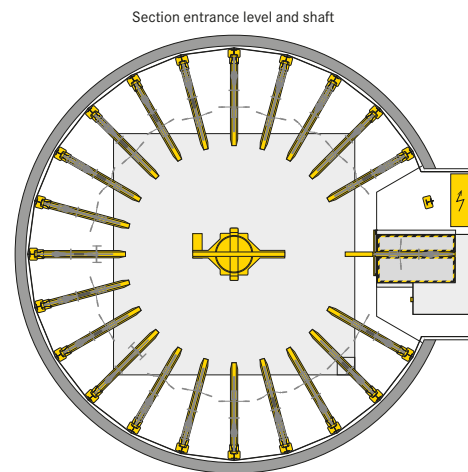
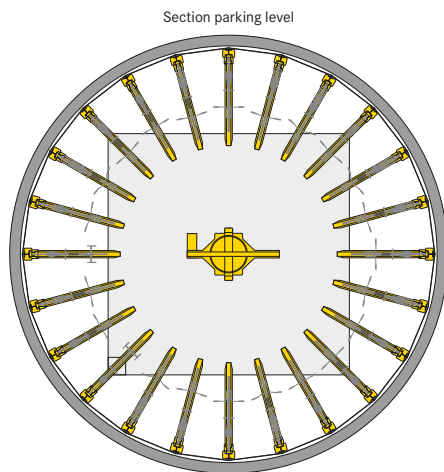

■ WÖHR Bikesafe 885/24 (114 parking places), handlebar width 83 cm

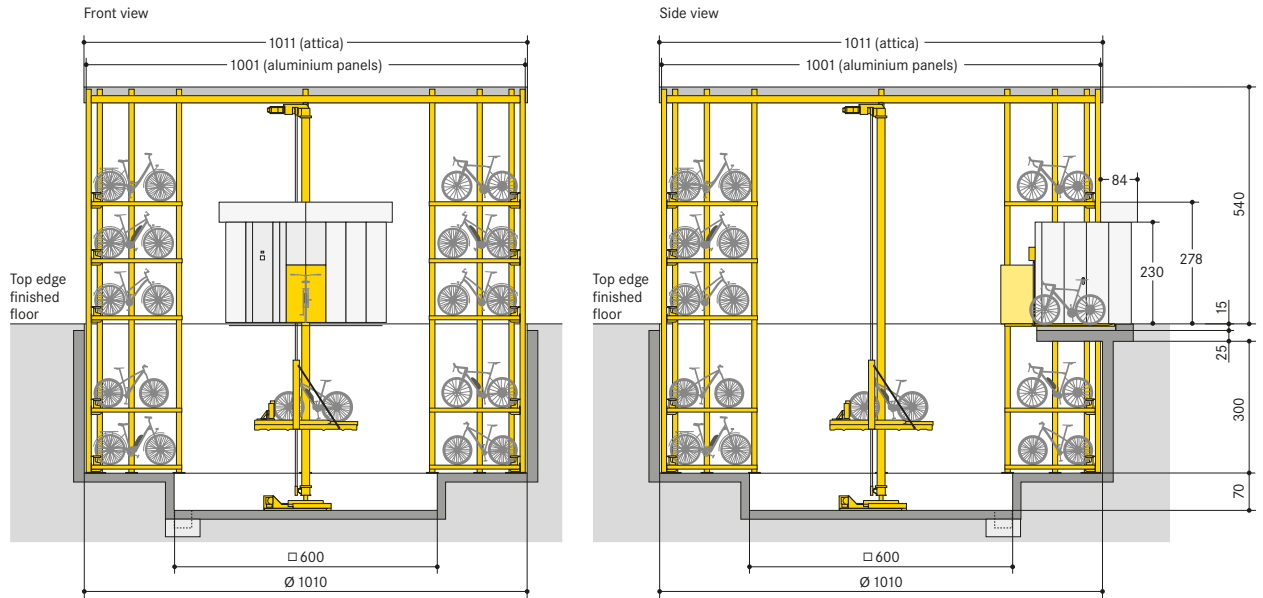

Note: if possible, provide an access door in the shaft area.

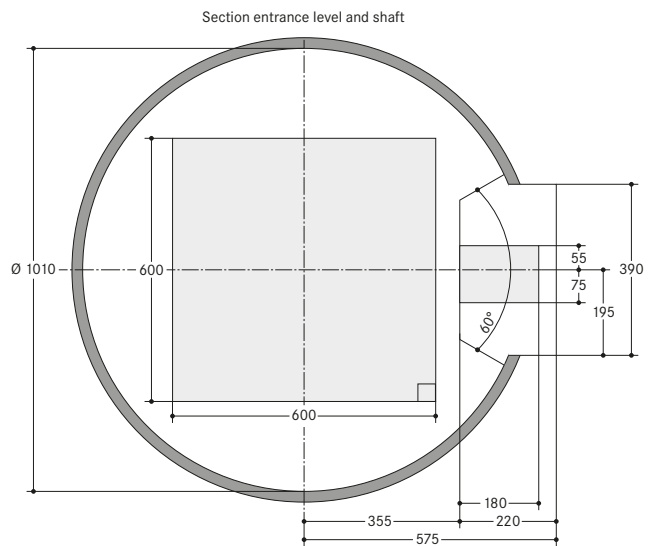
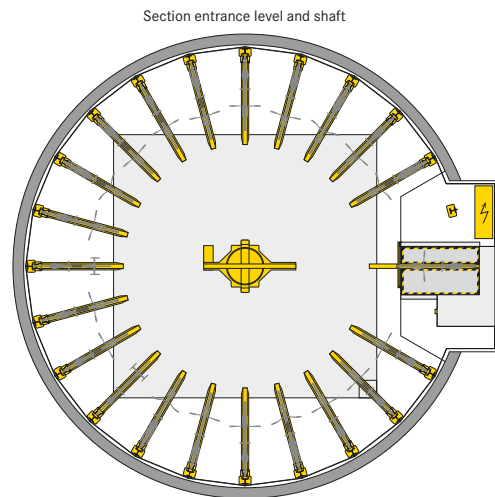
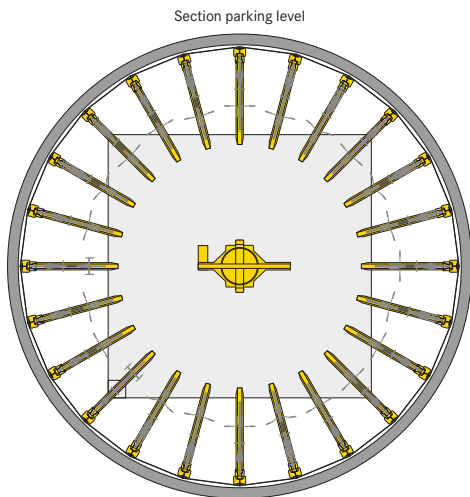

■ Dimensions

- all dimensions are minimum, finished dimensions
- tolerances must be taken into consideration
- all dimensions are given in cm